



**深圳市英展英科技有限公司**  
**PRODUCTION SPECIFICATION**  
**OF LCD MODULE**  
**PRODUCT NO: XC028BWV8629ACT**

---

<b>Customer Name:</b>			
<b>Customer Part Number:</b>			
<b>Approved By:</b>		<b>Date:</b>	

<b>Prepared By</b>	<b>Checked By</b>	<b>Approved By</b>

---

## Table of Contents

Revision History .....	3
1 General Specifications .....	4
2 Pin Assignment .....	5
3 Absolute Maximum Ratings .....	6
4 Electrical Characteristics .....	6
5 INTERFACE TIMING .....	8
5.1 System Bus Read/Write Characteristics .....	8
5.2 Power ON/OFF Timing .....	9
6 Optical Characteristics .....	10
7 Environmental / Reliability Test .....	14
8 Mechanical Drawing .....	15
9 Precautions For Use of LCD Modules .....	16

## Revision History

Rev	Issued Date	Description	Page	Editor
1.0	Mar 03.2023	First release	All	
2.0	May 29.2023	Change the OCA		

## 1 General Specifications

Feature		Specifications
<b>Display Spec.</b>	LCD type	2.76 inch
	Resolution (H*V)	480(RGB) ×480
	Technology Type	a-Si TFT
	Pixel Configuration	R.G.B. Vertical Stripe
	Display Mode	Normally Black
	Viewing Direction	ALL
	Gray Scale Inversion Direction	-
<b>Mechanical Characteristics</b>	OutlineDimensions (W x H x T) (mm)	95*95*4.77
	Active Area(mm)	70.13*70.13
	CTP View Area(mm)	/
	With /Without Touch screen	WithCTP
	Connector Type	0.5pitch 40pin
	Backlight Type	LED
	Weight (g)	TBD
<b>Electrical Characteristics</b>	Display Interface	3SPI+18RGB
	Number of color	262K
	Display Driver IC	ST7701S
	CTP IC	CST836U

Note 1: Viewing direction for best image quality is different from TFT definition. There is a 180 degree shift.

## 2 Pin Assignment

1	LED A	LED ANODE
2	LED K	LED CATHODE
3	LED K	LED CATHODE
4	GND	Ground
5	VCI	Power supply
6	RESET	Reset Signal ,Active Low
7	NC	NC
8	NC	NC
9	SDA	SPI Data signal
10	SCK	SPI Clock signal
11	CS	SPI Chip select signal
12	PCLK	RGB dot clock signal
13	DE	RGB data enable signal
14	VSYNC	RGB frame synchronizing signal
15	HSYNC	RGB line synchronizing signal
16~33	DB0~DB17	RGB data signal (DB0:BLUE LSB;DB5:BLUE MSB;DB6:GREEN LSB;DB11:GREEN, MSB;DB12:RED LSB;DB17:RED MSB)
34	GND	Ground
35	TP_INT	Touch Interrupt
36	TP_SDA	Touch IIC Data signal
37	TP_SCL	Touch IIC Clock signal
38	TP_RESET	Touch Reset Signal
39	TP_VCI	Touch Power supply
40	GND	Ground

**Note:**

1:3SPI+18RGB interface

### 3 Absolute Maximum Ratings

Item	Symbol	Value	Unit
Power supply voltage for logic	$V_{DD}$	0.3~4.8	V
Input voltage	$V_{in}$	$V_{DD}+0.3$	V
Operating temperature	$T_{opr}$	-20 to 70	°C
Storage temperature	$T_{stg}$	-30 to 80	°C

### 4 Electrical Characteristics

#### 4.1 Driving TFT LCD Panel

Item	Symbol	Min	Type	Max	Unit	Test condition
Operating voltage	$V_{DD}$	2.5	2.8	4.8	V	-
Supply current	$I_{DD}$	-	-	50	mA	$V_{DD}=2.8V, T_a=25^{\circ}C$
Input voltage	$V_{IH}$	0.8VDD	-	VDD	V	-
	$V_{IL}$	0	-	0.2VDD	V	
Input leakage current	$I_{IL}$	-1.0	-	1.0	$\mu A$	$V_{IN}=V_{DD}$ or $V_{SS}$

Note: Voltage greater than above may damage the module.

All voltages are specified relative to  $V_{SS}=0V$ .

#### 4.2 Driving Backlight

$T_a=25^{\circ}C$

Item	Symbol	Min	Typ	Max	Unit	Remark
Forward Current	$I_F$	--	80	--	mA	
Forward Voltage	$V_F$	-	6.6	-	V	
Connection mode		--	4P	--		
LED number	/		4		pcs	

Note1: Optical performance should be evaluated at  $T_a=25^{\circ}C$  only .If LED is driven by high current, high ambient temperature & humidity condition. The life time of LED will be reduced. Operating life means brightness goes down to 50% initial brightness. Typical operating life time is estimated data.

LED CIRCUIT DIAGRAM:

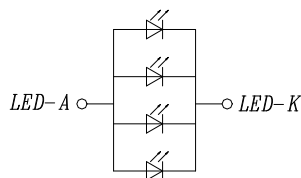

$$I_F=80mA \quad V_f=6.6V$$

4.3 Block Diagram

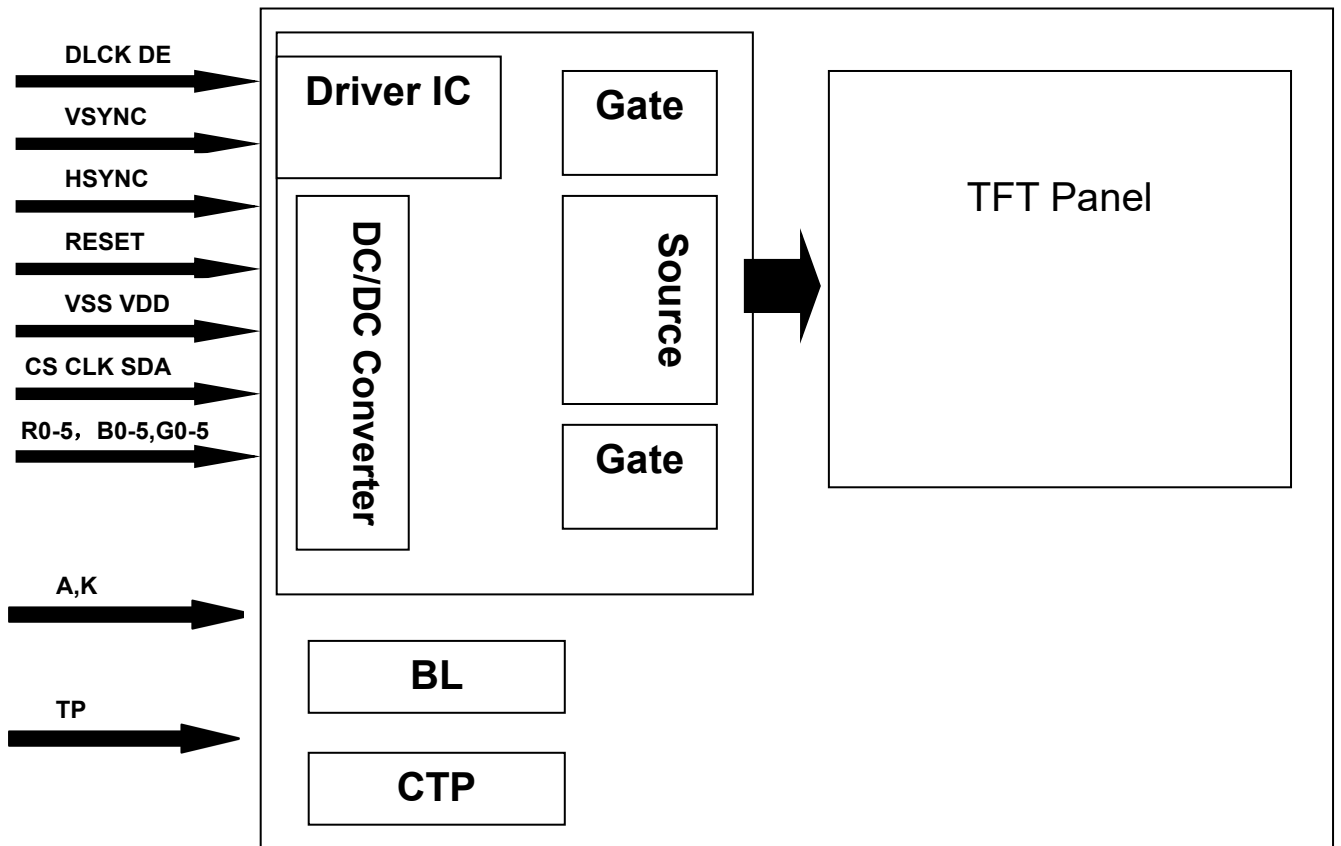

## 5 INTERFACE TIMING

### 5.1 System Bus Read/Write Characteristics.

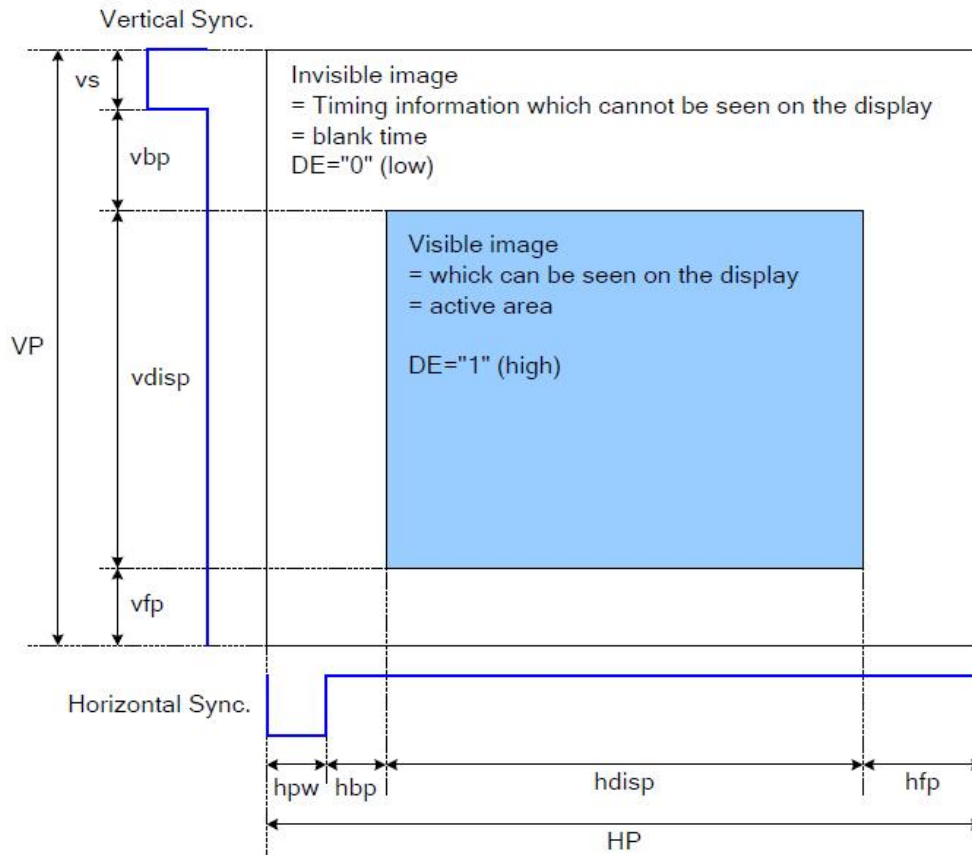

Please refer to the following table for the setting limitation of RGB interface signals.

Parameter	Symbol	Min.	Typ.	Max.	Unit
Horizontal Sync. Width	hpw	1	-	255	Clock
Horizontal Sync. Back Porch	hbp	1	--	255	Clock
Horizontal Sync. Front Porch	hfp	1	--	-	Clock
Vertical Sync. Width	vs	1	--	254	Line
Vertical Sync. Back Porch	vbp	1	--	254	Line
Vertical Sync. Front Porch	vfp	2	--	--	Line

Note:

1. Typical value are related to the setting frame rate is 60Hz..

### 5.2 Power ON/OFF Timing

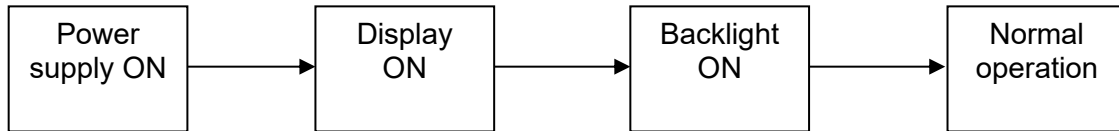
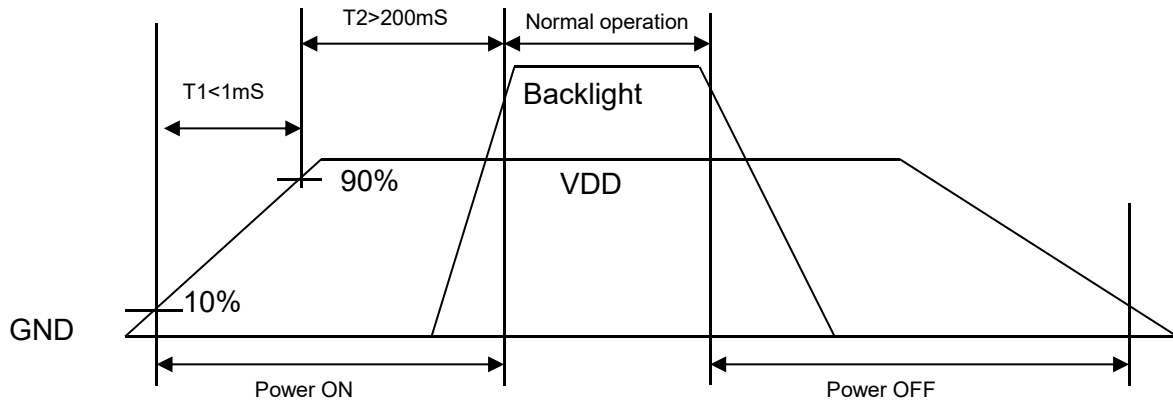

Power ON sequence

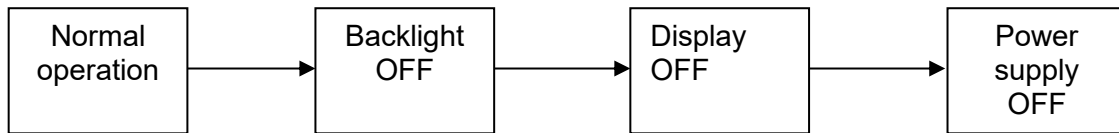

Power OFF sequence

## 6 Optical Characteristics

Ta=25°C

Item	Symbol	Condition	Min	Typ	Max	Unit	Remark
View Angles	$\theta T$	$CR \geq 10$	-	80	-	Degree	Note 2
	$\theta B$		-	80	-		
	$\theta L$		-	80	-		
	$\theta R$		-	80	-		
Contrast Ratio	CR	$\theta=0^\circ$	700	900	-	-	Note1 Note3
Response Time	$T_{ON}$	25°C	-	30	40	ms	Note1 Note4
	$T_{OFF}$		-	30	40		
Uniformity	U	-	70	80	-	%	Note1 Note6
NTSC	-	-	-	70	-	%	Note 5
Luminance	L		450	500	-	cd/m <sup>2</sup>	Note1 Note7

Test Conditions:

1.  $V_F=6.6V$ ,  $I_F=80mA$ , the ambient temperature is 25°C.
2. The test systems refer to Note 1 and Note 2.

**Note 1: Definition of optical measurement system.**

The optical characteristics should be measured in dark room. After 5 minutes operation, the optical properties are measured at the center point of the LCD screen. All input terminals LCD panel must be ground when measuring the center area of the panel.

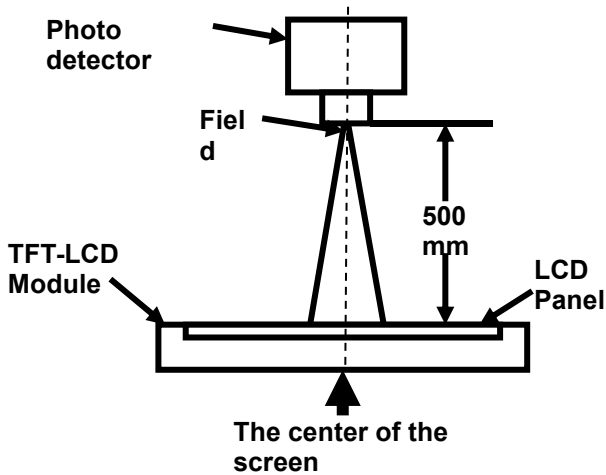

Item	Photo detector	Field
Contrast Ratio	SR-3A	1°
Luminance		
Chromaticity		
Lum Uniformity	BM-7A	2°
Response Time		

**Note 2: Definition of viewing angle range and measurement system.**

viewing angle is measured at the center point of the LCD by CONOSCOPE(ergo-80).

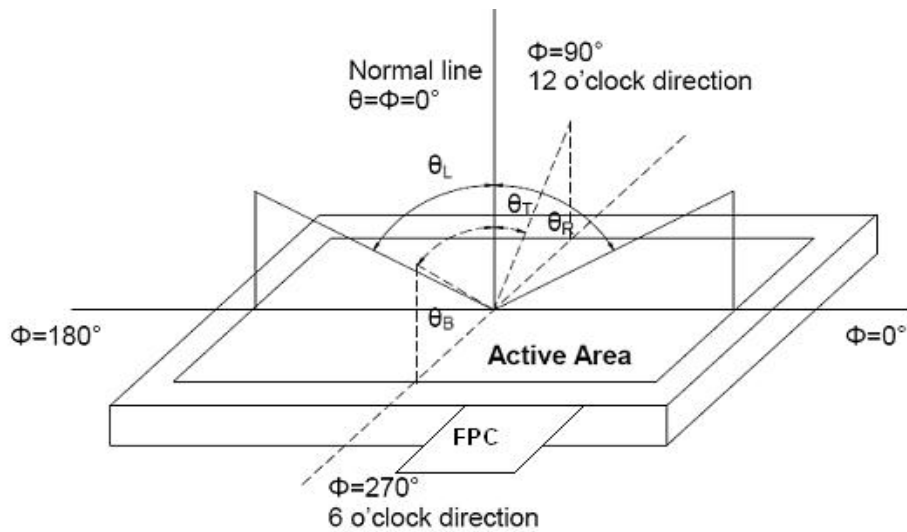

Fig. 1 Definition of viewing angle

**Note 3: Definition of contrast ratio**

$$\text{Contrast ratio (CR)} = \frac{\text{Luminance measured when LCD is on the "White" state}}{\text{Luminance measured when LCD is on the "Black" state}}$$

"White state ":The state is that the LCD should be driven by  $V_{\text{white}}$ .

"Black state": The state is that the LCD should be driven by  $V_{\text{black}}$ .

$V_{\text{white}}$ : To be determined     $V_{\text{black}}$ : To be determined.

**Note 4: Definition of Response time**

The response time is defined as the LCD optical switching time interval between "White" state and "Black" state. Rise time ( $T_{\text{ON}}$ ) is the time between photo detector output intensity changed from 90% to 10%. And fall time ( $T_{\text{OFF}}$ ) is the time between photo detector output intensity changed from 10% to 90%.

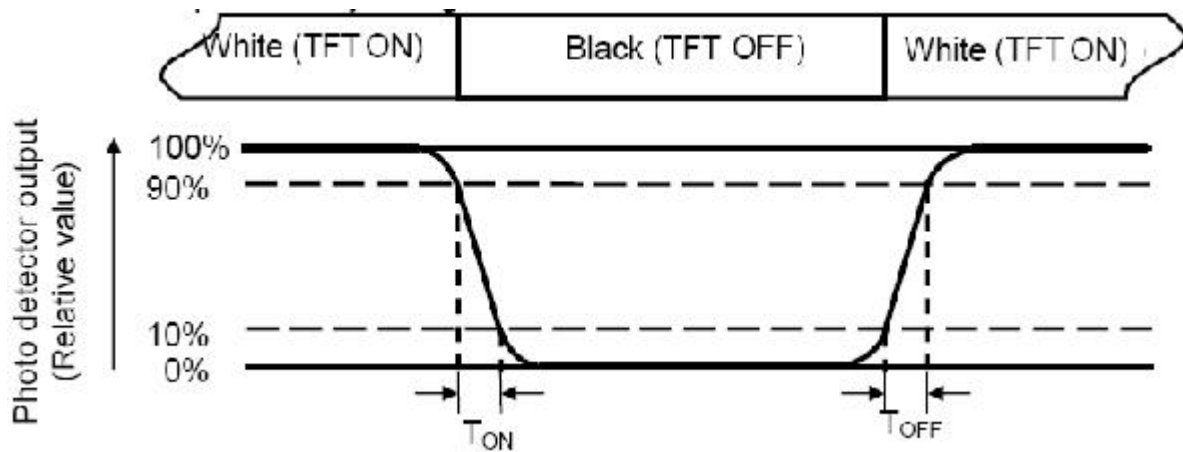
**Note 5: Definition of color chromaticity (CIE1931)**

Color coordinates measured at center point of LCD.

**Note 6: Definition of Luminance Uniformity**

Active area is divided into 9 measuring areas (Refer Fig. 2). Every measuring point is placed at the center of each measuring area.

Luminance Uniformity (U) =  $L_{min} / L_{max}$

L-----Active area length W----- Active area width

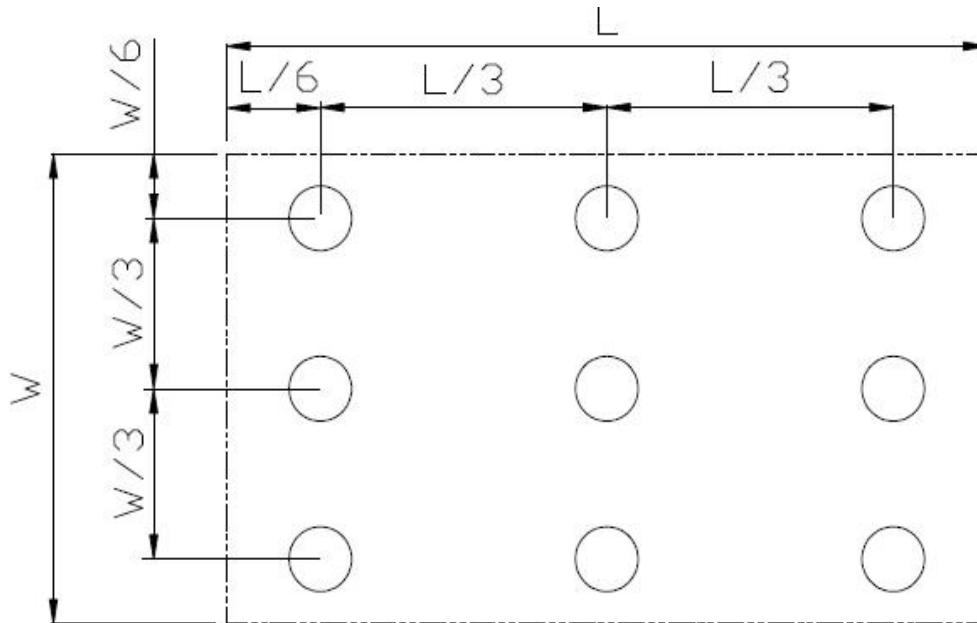

Fig. 2 Definition of uniformity

$L_{max}$ : The measured maximum luminance of all measurement position.

$L_{min}$ : The measured minimum luminance of all measurement position.

**Note 7: Definition of Luminance:**

Measure the luminance of white state at center point.

## 7 Environmental / Reliability Test

Item	Condition	Time (hrs)	Assessment
High temp. Storage	80°C	120	No abnormalities in functions and appearance
High temp. Operating	70°C	120	
Low temp. Storage	-30°C	120	
Low temp. Operating	-20°C	120	
Humidity	40°C/ 90%RH	120	
Thermal Shock(Non-operation)	-20°C ← 25°C →70°C (0.5 hour ← 5 min → 0.5 hour)	10cycles	

### Remark:

- 1.The test samples should be applied to only one test item.
- 2.Sample size for each test item is 1~10pcs.
- 3.In case of malfunction defect caused by ESD damage, if it would be recovered to normal state after resetting, it would be judged as a good part.

# 8 Mechanical Drawing

1	2	3	4	5	6	7	8
<p>深圳市英展英科技有限公司 Shenzhen Yingzhan Ying Technology Co., Ltd</p>		<p>DESIGN: (设计) HOU</p>	<p>CHECKED: (检查)</p>	<p>APPROVED: (批准)</p>	<p>SPECIFICATION</p>	<p>CUSTOMER'S CODE: (客户型号) YZY S CODE: (英展英料号) XC028BWV8629ACT</p>	<p>规格 EDITION: (版本号) 02</p>
<p>Date: (日期) 2023.05.29</p>		<p>Page: (页数) 1/1</p>		<p>图纸视角: </p>		<p>EDITION: (版本号) 02</p>	

## ROHS

正视图

侧视图

背视图

**PIN SYMBOL**

1	LEDA
2	LEDK1
3	LEDK2
4	GND
5	VCI
6	RESET
7	NC
8	NC
9	SDA
10	SCK
11	CS
12	DC1K
13	DE
14	VSYNC
15	HSYNC
16-33	DB01 DB17
34	GND
35	TP INT
36	TP SDA
37	TP SCL
38	TP RESET
39	TP VCI
40	GND

**技术参数**

- 结构G+F: Cover Glass+OCA+ITO FILM+PPC Cover Glass 2.0MM, OCA:0.125mm, ITO FILM:0.125mm,总厚度: 2.25±0.15mm;
- IC型号: CST896U, 通道数: 28, 支持单点+手势触摸
- 透光率: ≥82%,TP分辨率: 480\*480(可按客户要求);
- 工作温度范围:-20°C~+70°C,≤90%RH; 储存温度范围:-30°C~+80°C,≤90%RH;
- 表面硬度: ≥6H (750gf/笔等硬度测试);
- Cover Glass材质: (旭硝子) 钢化玻璃,产品符合RoHS标准;
- 其他未标注公差: ±0.20;

**LED CIRCUIT DIAGRAM:**

IF=10mA VF=1.2~1.8 V 双芯片

**Interface description 1,**  
TP power 3.3V, all IO port voltage also 3.3V,  
interface selection as follows: 3SPI + ROB (Swire SPI)

**弯折示意图**

弯折出货

**弯折示意图**

**1. Unit:mm.**

- Modification rev. number.
- All radii without dimension R0.3mm.
- All draft angles to be 1.5°
- Unspecified Tolerances is : ±0.20mm.
- LED Driver IC: ST7701S
- LED Driver Voltage : 3.3V
- Color : White
- Operating Temperature : -20° ~ +70° C
- Storage Temperature : -30° ~ +80° C
- Requirements on Environmental Protection: ROHS HSFR

**客户名称** \_\_\_\_\_

**Approval Date:** \_\_\_\_\_

**Approval By:** \_\_\_\_\_

Please Confirm This Drawing On/Before  
请 签 回 此 图

---

## 9 Precautions For Use of LCD Modules

### 9.1 Handling Precautions

9.1.1.1 The display panel is made of glass. Do not subject it to a mechanical shock by dropping it from a high place, etc.

9.1.1.2 If the display panel is damaged and the liquid crystal substance inside it leaks out, be sure not to get any in your mouth, if the substance comes into contact with your skin or clothes, promptly wash it off using soap and water.

9.1.1.3 Do not apply excessive force to the display surface or the adjoining areas since this may cause the color tone to vary.

9.1.1.4 The polarizer covering the display surface of the LCD module is soft and easily scratched. Handle this polarizer carefully.

9.1.1.5 If the display surface is contaminated, breathe on the surface and gently wipe it with a soft dry cloth. If still not completely clear, moisten cloth with one of the following solvents:

- Isopropyl alcohol
- Ethyl alcohol

Solvents other than those mentioned above may damage the polarizer. Especially, do not use the following:

- Water
- Ketone
- Aromatic solvents

9.1.1.6 Do not attempt to disassemble the LCD Module.

9.1.1.7 If the logic circuit power is off, do not apply the input signals.

9.1.1.8 To prevent destruction of the elements by static electricity, be careful to maintain an optimum work environment.

9.1.1.9 Be sure to ground the body when handling the LCD Modules.

9.1.1.10 Tools required for assembly, such as soldering irons, must be properly ground.

9.1.1.11 To reduce the amount of static electricity generated, do not conduct assembly and other work under dry conditions.

9.1.1.12 The LCD Module is coated with a film to protect the display surface. Be care when peeling off this protective film since static electricity may be generated.

9.1.1.13 Storage precautions

9.1.1.14 When storing the LCD modules, avoid exposure to direct sunlight or to the light of fluorescent lamps.

9.1.1.15 The LCD modules should be stored under the storage temperature range. If the LCD modules will be stored for a long time, the recommend condition is:

9.1.1.16 The LCD modules should be stored in the room without acid, alkali and harmful gas.

### 9.2 Transportation Precautions

The LCD modules should be no falling and violent shocking during transportation, and also should avoid excessive press, water, damp and sunshine.